

# Denver Basic 1120

Flame Tray 900mm

With Remote control, Bluetooth/ App

and six flame levels incl. ECO

With one 80mm high glass screens

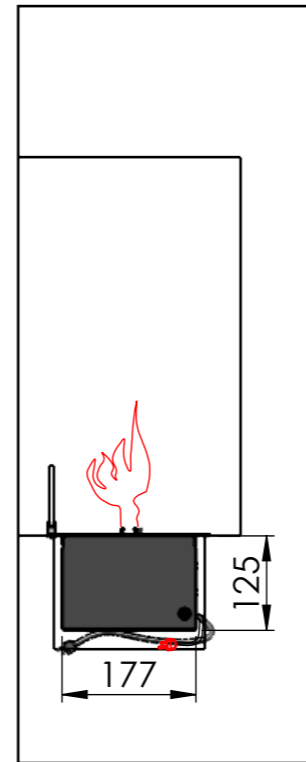
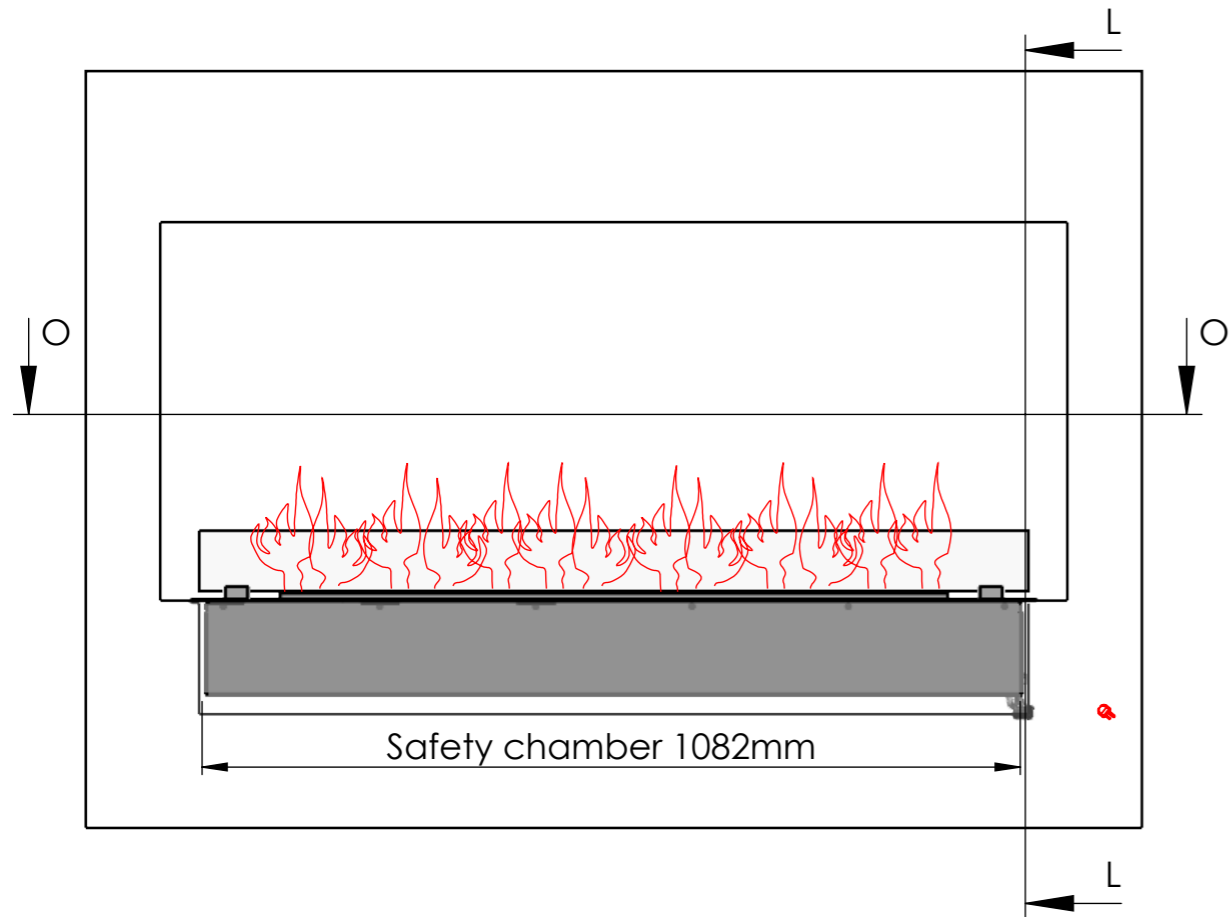

SECTION L-L

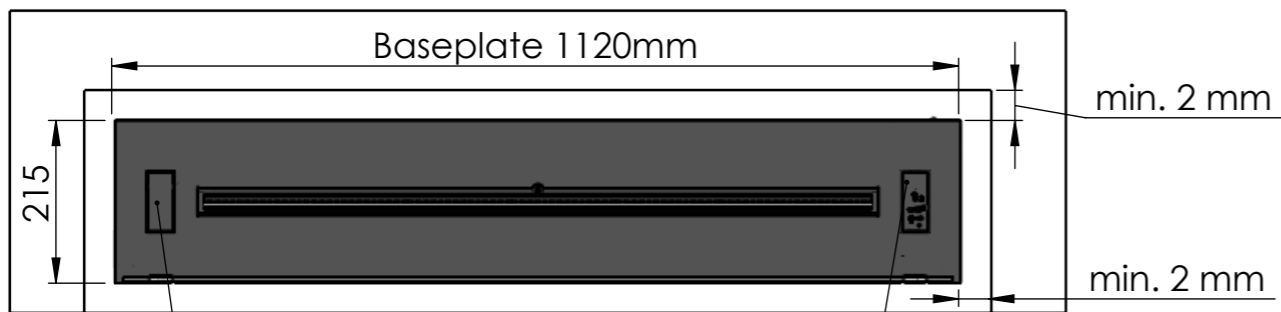

SECTION O-O

Fuel inlet  
Black

Control Panel  
Black

**Please Note**, if using the minimum required dimensions for the wall cut-out, the wall in front of the safety chamber becomes very thin, only 7,5mm.

Mounting if top plate is to rest on top of surrounding surface  
Note: base plate can get hot! Ensure that the surrounding surface can withstand a temperature of around 50 degrees C.

## Wall cut-out dimensions

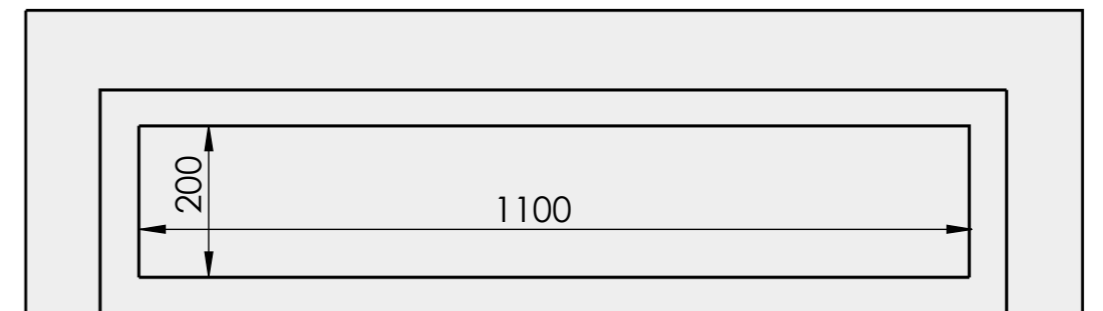
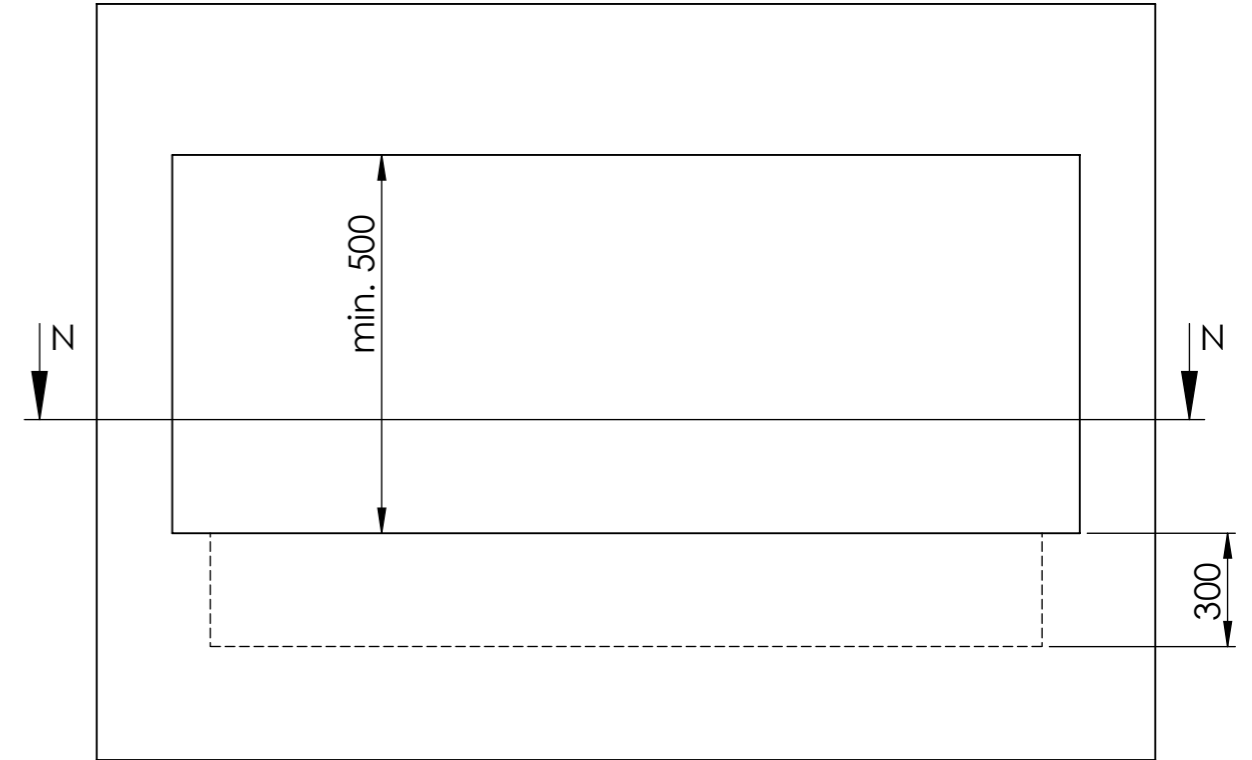

SECTION N-N

<b>Dimensions are in millimeters</b>		 DecoFlame ApS Vang Mark 2 9380 Vestbjerg TLF: +45 96 30 48 00 www.decoflame.com	<b>SCALE: 1:10</b>
MATERIAL:			FORMAT: A3
WEIGHT:		Order Number: PRINCIPLE Denver Basic 1120 - FT900 - 1120x215x125mm - 1x glass	Page 1 OF 2
REVISION:			DWG NO.
Copyright of DecoFlame ApS Denmark, whose property this document remains. No part thereof may be disclosed, copied, duplicated or in any other way made use of, except with the approval of DecoFlame ApS DecoFlame Denmark.		<b>Denver Basic 1120</b>	

# IMPORTANT INFORMATION

Particulars of the wall in which the fireplace shall be installed

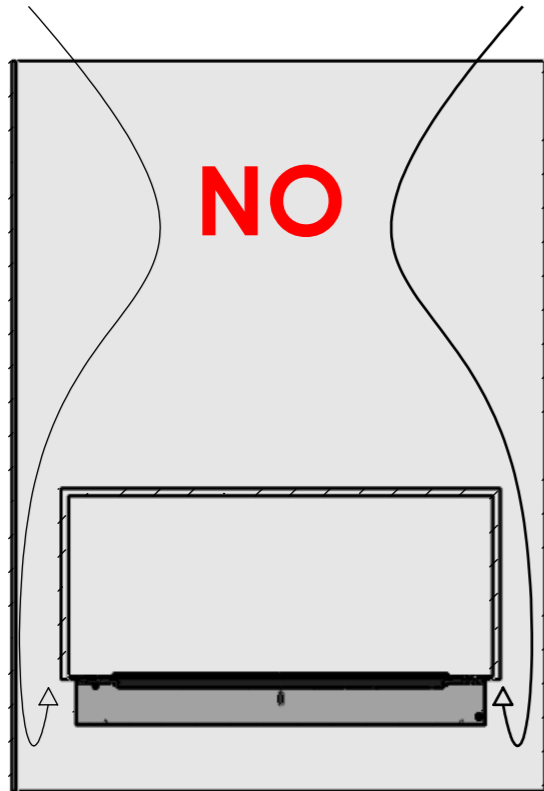

**DO NOT!** install the fireplace in a wall construction which is open above and below the fireplace. The warm air will cause turbulences inside this hollow construction which will have a negative impact on the flames.

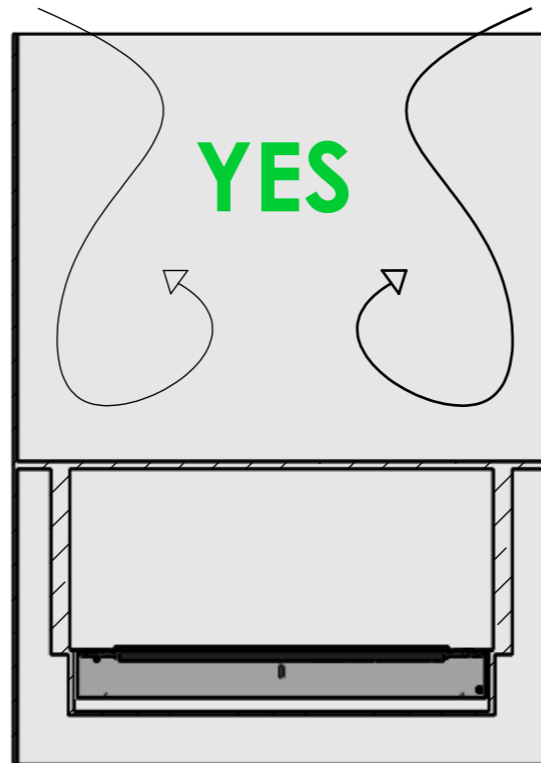

**DO!** install the fireplace in an open-wall construction, which is closed above and below the fireplace. Make sure to create a closed cavity for the section below the base plate of the fire.

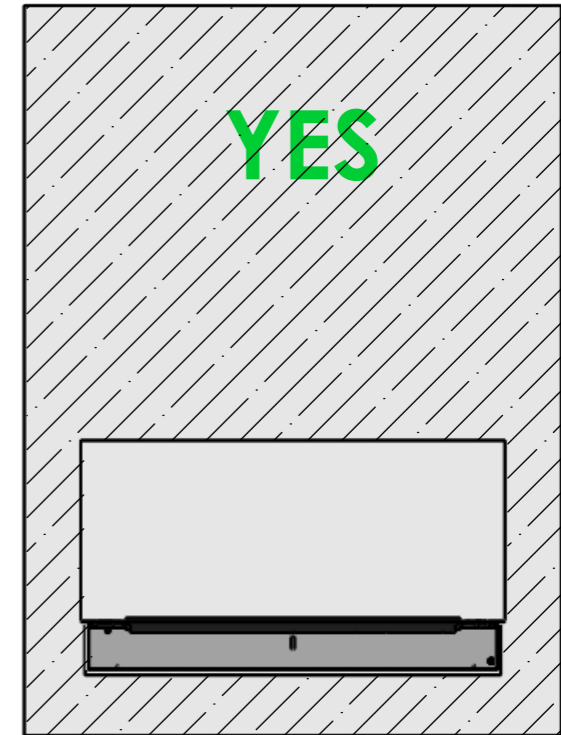

**DO!** install the fireplace in a massive wall (made of bricks, stone or gas beton) using the wall cut-out dimensions mentioned on the previous page.

<b>Dimensions are in millimeters</b>		 DecoFlame ApS Vang Mark 2 9380 Vestbjerg TLF: +45 96 30 48 00 www.decoflame.com	<b>SCALE: 1:20</b>
MATERIAL:			FORMAT: A3
WEIGHT:		Order Number:	Page 2 OF 2
REVISION:			
Copyright of DecoFlame ApS Denmark, whose property this document remains. No part thereof may be disclosed, copied, duplicated or in any other way made use of, except with the approval of DecoFlame ApS DecoFlame Denmark.		DWG NO.	Close the wall recess