

# Denver Basic 720

Flame Tray 500mm

With Remote control, Bluetooth / App  
and six flame levels incl. ECO  
with one 80mm high glass screen

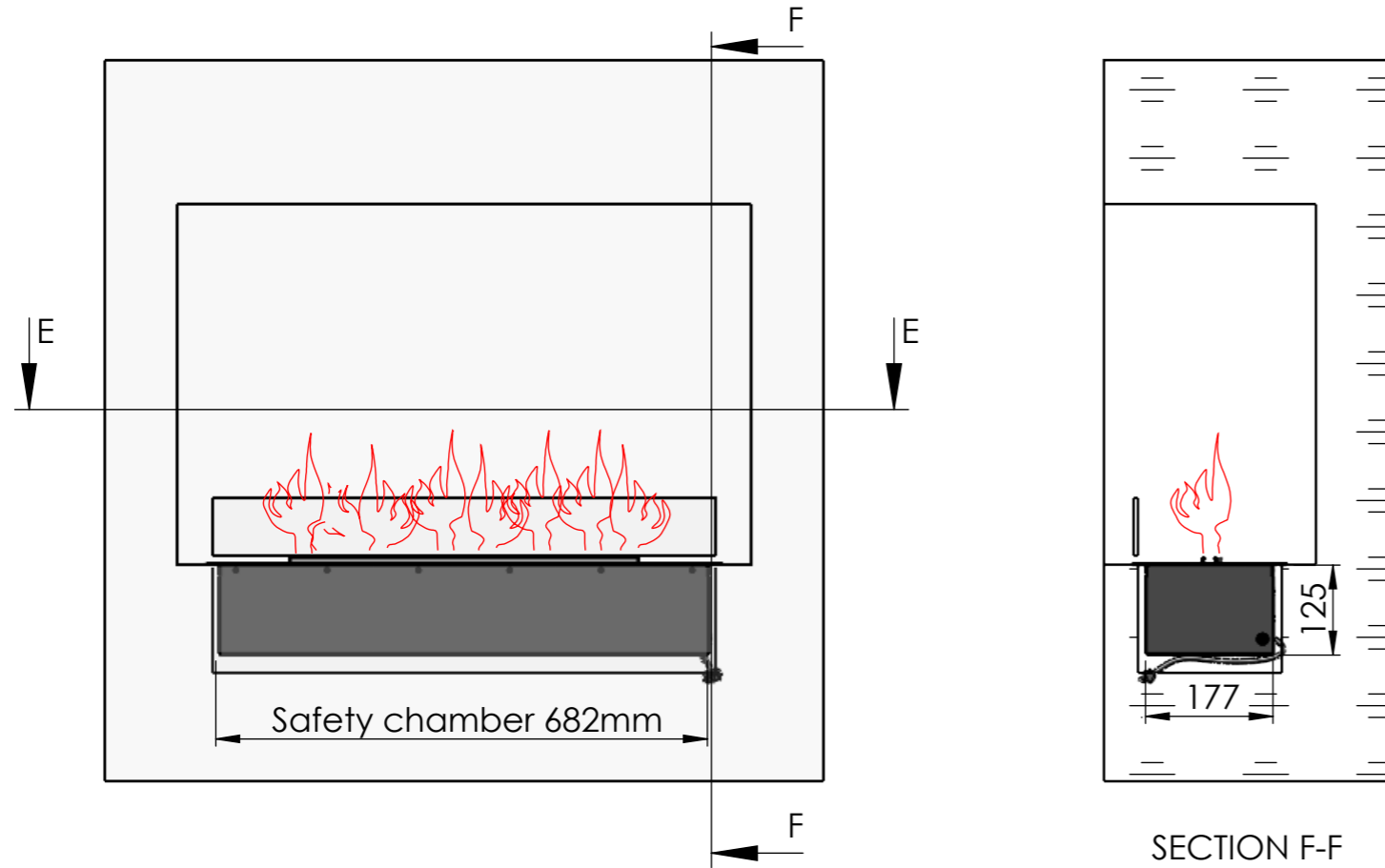

SECTION F-F

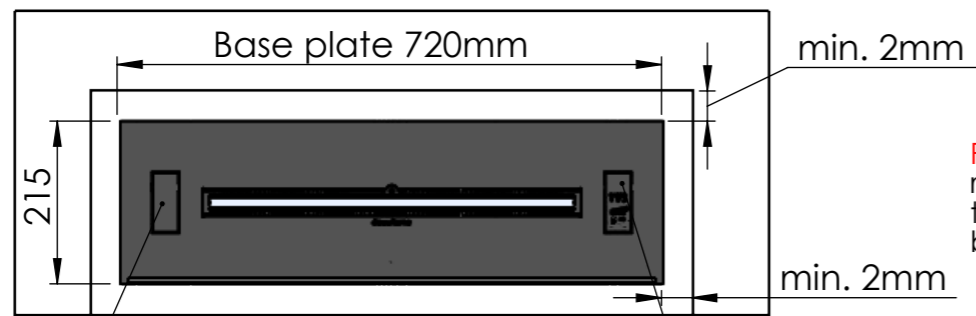

Fuel Inlet  
BSS

Control Panel  
White

**Please Note**, if using the minimum required dimensions for the wall cut-out, the wall in front of the safety chamber becomes very thin, only 7,5mm.

Mounting if top plate is to rest on top of surrounding surface  
Note: base plate can get hot! Ensure that the surrounding surface can withstand a temperature of around 50 degrees C.

## Wall cut-out dimensions

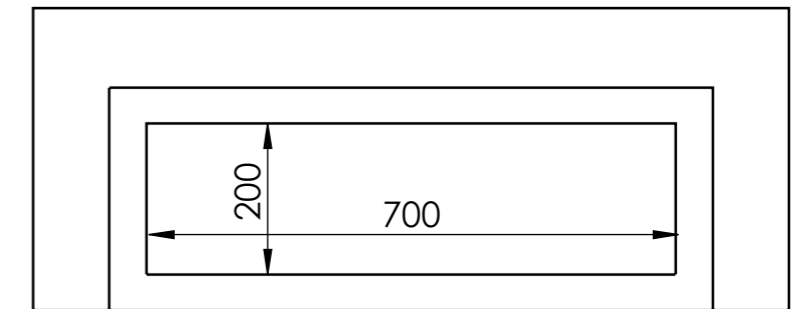
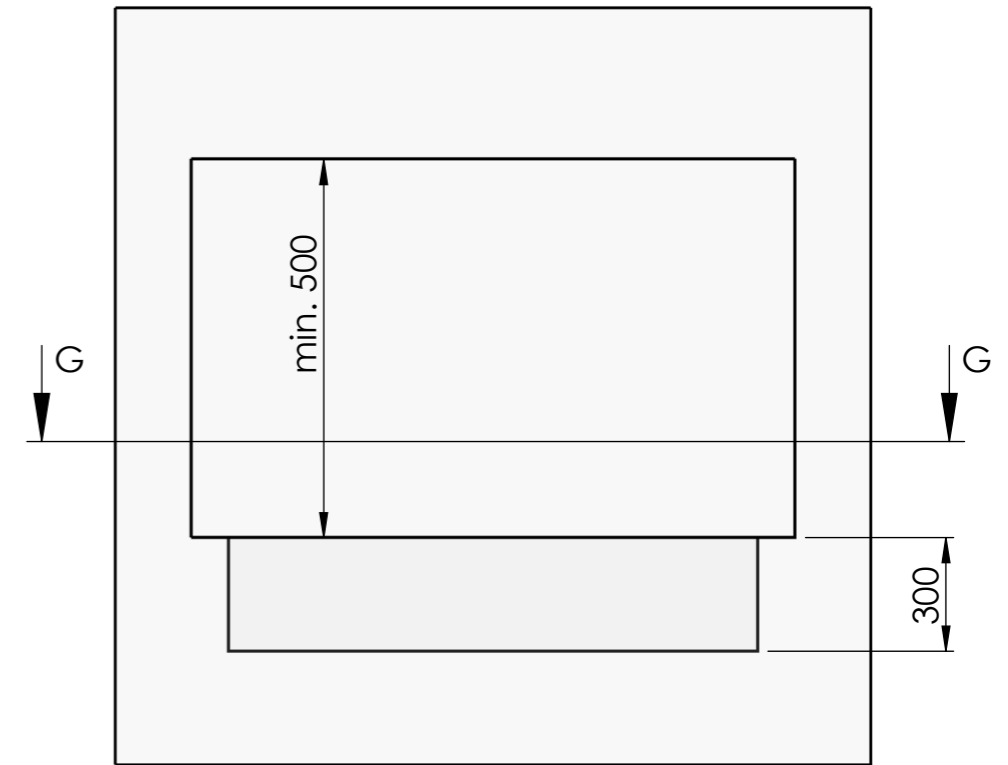

SECTION G-G

<b>Dimensions are in millimeters</b>		 DecoFlame ApS Vang Mark 2 9380 Vestbjerg TLF: +45 96 30 48 00 www.decoflame.com	<b>SCALE: 1:10</b>
MATERIAL:			FORMAT: A3
WEIGHT:	kg	Order Number:	Page 1 OF 2
REVISION:		<b>PRINCIPLE Denver Basic 720 - FT500</b> - 720x215x125mm - 1x glass	
Copyright of DecoFlame ApS Denmark, whose property this document remains. No part thereof may be disclosed, copied, duplicated or in any other way made use of, except with the approval of DecoFlame ApS DecoFlame Denmark.		DWG NO.	<b>Denver Basic 720</b>

# IMPORTANT INFORMATION

Particulars of the wall in which the fireplace shall be installed

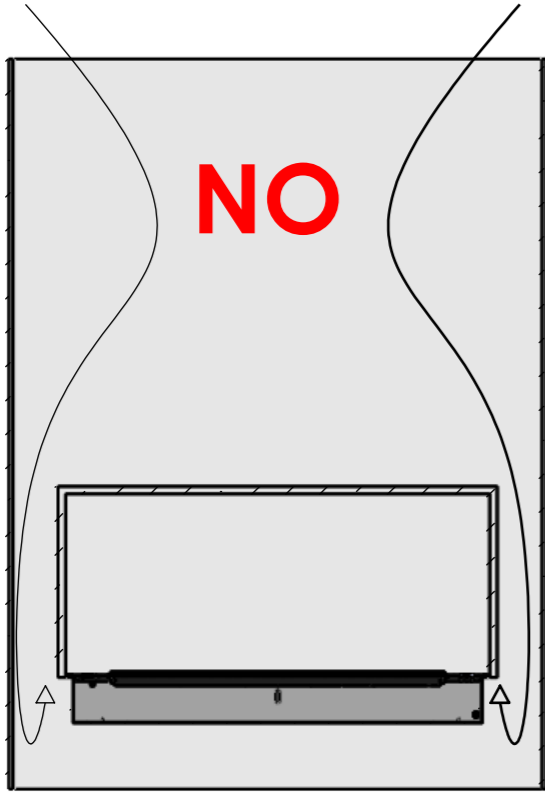

**DO NOT!** install the fireplace in a wall construction which is open above and below the fireplace. The warm air will cause turbulences inside this hollow construction which will have a negative impact on the flames.

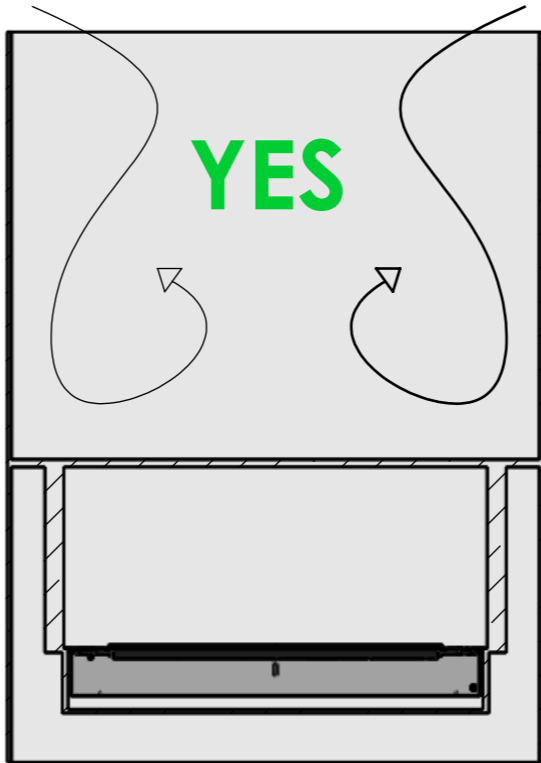

**DO!** install the fireplace in an open-wall construction, which is closed above and below the fireplace. Make sure to create a closed cavity for the section below the base plate of the fire.

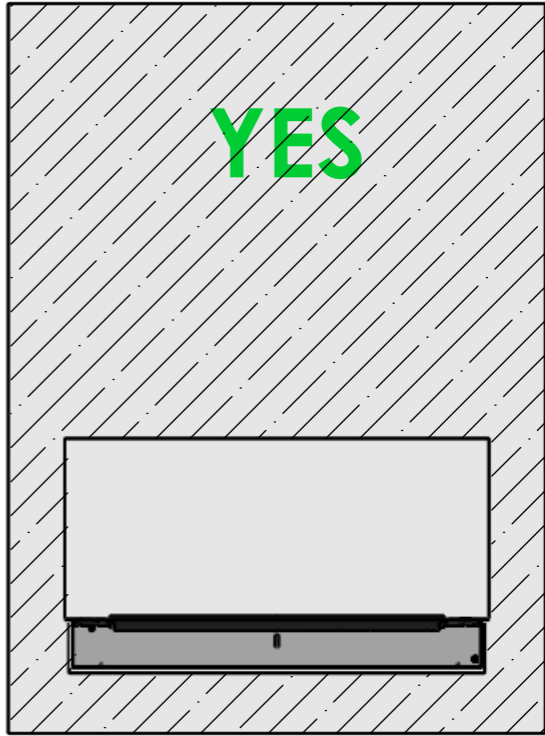

**DO!** install the fireplace in a massive wall (made of bricks, stone or gas beton) using the wall cut-out dimensions mentioned on the previous page.

<b>Dimensions are in millimeters</b>		 DecoFlame ApS Vang Mark 2 9380 Vestbjerg TLF: +45 96 30 48 00 www.decoflame.com	<b>SCALE: 1:20</b>
MATERIAL:			FORMAT: A3
WEIGHT:		Order Number:	Page 2 OF 2
REVISION:			
Copyright of DecoFlame ApS Denmark, whose property this document remains. No part thereof may be disclosed, copied, duplicated or in any other way made use of, except with the approval of DecoFlame ApS DecoFlame Denmark.		DWG NO.	<b>Close the wall recess</b>